

# USER MANUAL

RAIS Rondo 92 & Rondo 120



We cannot be held responsible for any misprints.

# Rais Rondo 92

# Rais Rondo 120

Modified : 2

Date : December 2009

INTRODUCTION .....	4
WARRANTY .....	4
SPECIFICATIONS .....	5
CONVECTION .....	6
INSTALLATION INSTRUCTION .....	7
CHIMNEY .....	8-9
INSTALLATION.....	11
OPERATION OF SWIVEL BASE (RAIS RONDO 120) .....	11
ADJUSTMENT OF CHIMNEY CONNECTION .....	12-13
INSTALLATION DISTANCE IN CASE OF COMBUSTIBLE WALL .....	14
GENERAL INSTALLATION (RIGHT ANGLE) SECURE BASE .....	15
CORNER INSTALLATION 45° .....	15
360° SWIVEL BASE .....	16
INSTALLATION DISTANCE IN CASE OF NON-COMBUSTIBLE WALL.....	16
FOR THE INSTALLER .....	17
OPERATING INSTRUCTION .....	18
FUEL .....	18-19
DRYING AND STORAGE .....	19
REGULATION OF COMBUSTION AIR .....	19
ROOM VENTILATION AND STOVES .....	19
USING THE WOOD BURNING STOVE .....	19
ADJUSTMENT OF AIR DAMPER .....	20
CONTROL .....	20
FIRST USAGE .....	21
LIGHTING AND FUELLING.....	22-23
CLEANING AND CARE .....	24
CLEANING OF THE FLUE WAYS .....	25
INTERRUPTION OF OPERATION .....	26
ACCESSORIES AND SPARE PARTS.....	27
SPARE PART DIAGRAMS RONDO 92.....	28-29
SPARE PART DIAGRAMS RONDO 120.....	30-31

## Introduction

Thank you for purchasing a RAIS wood burning stove. These appliances have been approved by HETAS Ltd as intermittent operating appliances for burning wood logs only.

A RAIS wood burning stove is more than just a heat source: it also shows that you care about design and quality in your home.

To make the most of your wood burning stove it is important that you read the manual thoroughly, before installing and using it.

In the case of warranty coverage, and for general queries regarding your wood burning stove, it is important that you know the stove's production number.

We therefore recommend that you note down the number in the table below. The production number is located on the back of the stove at the bottom.

## Warranty

Your RAIS wood burning stove comes with a 5 year warranty. The warranty, however, does not cover heat-insulating materials, glass and seals.

Any alterations made to the stove will void the warranty.



Distributor:

Date:

## Specifications

	RAIS Rondo 92	RAIS Rondo 120
Nominal output (kW):	5	5
Min./Max. output(kW):	3-8	3-8
Heating area(m <sup>2</sup> ):	ca. 100	ca. 100
Stove's width/depth/height (mm):	490-490-920	490-490-1200
Combustion chamber's width/depth/height(mm):	350-290-355	350-290-355
Recommended amount of wood when fuelling (kg): (Distributed on 2-3 logs of wood of approx. 25 cm)	1,5	1,5
Min. uptake / Min. draught(Pascal):	-12	-12
Weight(kg):	115	140
Smoke gas mass flow (g/s):	4,7	4,7
Smoke gas temperature (°C):	246	246
Intermittent operation:	Fueling should be undertaken within 3 hours	

## Convection

RAIS stoves are convection stoves. This means that the stove's back and side panels are not over-heated. Convection means that there is a circulation of air, which ensures that the heat is distributed more evenly throughout the entire room. The cold air is sucked in at the base of the stove up through the convection channel, which runs along the stove's combustion chamber. The heated air pours out at the top of the stove, which ensures a circulation of warm air throughout the room.

The stoves are equipped with a "cold" lever – RAIS special feature – which means you could almost do away with gloves. Be aware, however, that all exterior surfaces become hot during use - so take extreme care.

## Installation instructions

The following pages give instructions for the safe and proper installation of this heating appliance in the UK. These instructions cover the basic principles of installation, although detail may need slight modification to suit particular local site conditions. In all cases the installation must comply with current UK Building Regulations, Local Authority Byelaws and other specifications or regulations as they affect the installation of the stove. Please note that it is a legal requirement under England and Wales Building Regulations that the installation of the stove is either carried out under Local Authority Building Control approval or is installed by a Competent Person registered with a Government approved Competent Persons Scheme. HETAS Ltd operate such a Scheme and a listing of their Registered Competent Persons can be found on their website at [www.hetas.co.uk](http://www.hetas.co.uk).

It should be noted that the current Building Regulations requirements are given in Approved Document J. These requirements may also be met by adopting the relevant recommendations given in British Standards BS 8303 and BS EN 15287-1.

### WARNING: Health and Safety Advice Notice

The installation of this heating appliance is governed by the Health and Safety at Work Act 1974. It is the responsibility of the installer to ensure that all requirements of this Act are met during the installation works. Attention is drawn in particular to the following:

#### Handling:

The appliance is a heavy item and adequate facilities must be available for loading, unloading and site handling.

#### Fire Cement:

Some types of fire cement are caustic and should not be allowed to come into contact with the skin. Protective gloves should be worn when handling fire cement. In case of contact with the skin wash immediately with plenty of water.

#### Asbestos:

This stove contains no asbestos. If there is a possibility of disturbing any asbestos in the course of installation then please seek specialist guidance and use appropriate protective equipment.

#### Metal Parts:

When installing or servicing this stove care should be taken to avoid the possibility of personal injury.

### Important Warning –Preparatory Work and Safety Checks:

- This stove must not be installed into a chimney that serves any other heating appliance.
- There must not be an extractor fan fitted in the same room as the stove as this can cause the stove to emit fumes into the room.
- If this appliance is installed into an existing chimney, the chimney must first be swept and examined for soundness and suitability before the appliance is installed (see also section headed “Chimney”).

## Chimney

The chimney is the driving force which makes the stove function. In order for the stove to perform satisfactorily the chimney height must be sufficient to ensure the correct draught of 14 to 18 Pa so as to clear the products of combustion and prevent problems of smoke emanating into the room when firing.

NOTE: A chimney height of not less than 4.5 metres measured vertically from the outlet of the stove to the top of the chimney should be satisfactory. Alternatively the calculation procedure given in BS 5854:1980 may be used as the basis for deciding whether a particular chimney design will provide sufficient draught.

The outlet from the chimney should be above the roof of the building in accordance with the provisions of Building Regulations Approved Document J.

If installation is into an existing chimney then it must be sound and have no cracks or other faults which might allow fumes into the house. Older properties, especially, may have chimney faults or the cross section may be too large i.e. more than 230 mm x 230 mm. Remedial action should be taken, if required, seeking expert advice, if necessary. If it is found necessary to line the chimney then a flue liner suitable for solid fuel must be used in accordance with Building Regulations Approved Document J.

Any existing chimney must be clear of obstruction and have been swept clean immediately before installation of the stove. If the stove is fitted in place of an open fire then the chimney should be swept one month after installation to clear any soot falls which may have occurred due to the difference in combustion between the stove and the open fire.

If there is no existing chimney then either a prefabricated block chimney in accordance with Building Regulations Approved Document J or a twin walled insulated stainless steel flue to BS 4543 can be used. These chimneys must be fitted in accordance with the manufacturer's instructions and Building Regulations.

A single wall metal fluepipe is suitable for connecting the stove to the chimney but is not suitable for using for the complete chimney. The chimney and connecting fluepipe must have a minimum diameter of 150 mm and its dimension should be not less than the size of the outlet socket of the stove which is 150 mm in diameter. Any bend in the chimney or connecting fluepipe should not exceed 45°. 90°bends should not be used.

Combustible material should not be located where the heat dissipating through the walls of fireplaces or flues could ignite it. Therefore when installing the stove in the presence of combustible materials due account must be taken of the guidance on the separation of combustible material given in Building Regulations Approved Document J and also in these stove instructions.

If it is found that there is excessive draught in the chimney then either an adjustable flue damper or alternatively a draught stabiliser should be fitted. The adjustable flue damper should not close off the flue entirely but should in its closed position leave a minimum continuous opening free area of at least 20 % of the total cross sectional area of the flue or fluepipe.

Adequate provision e.g. easily accessible soot door or doors must be provided for sweeping the chimney and connecting fluepipe.

You should also familiarise yourself with the draught conditions for chimneys with 2 flues.

The flue outlet spigot is 150 mm in diameter.

For strong draughts, the chimney or flue should be fitted with a draught stabiliser. In which case, it is important to ensure that there is a free flow-through area of minimum 20 cm<sup>2</sup> when the regulating gate is shut. Otherwise, the fuel energy may not be used optimally. If, at any time, you are unsure about the condition of the chimney, you should contact a chimney sweep.

Remember that access to the access door should be kept clear.

## Rondo Manufacturer's Plate

<b>CE</b>	
Producent RAIS A/S, Industrivej 20, 9900 Frederikshavn, Danmark 07	
EN 13240:2001+A2:2004 Anordning til træ	
EC.nr. 407	
<b>RONDO 92</b>	
Afstand til brændbart, bagvæg	: 150 mm
Afstand til brændbart, sidevæg	: 350 mm
Afstand til brændbart, møblering	: 1050 mm
CO emission	: 0,17 %
Røggas temperatur	: 246 °C
Nominel effekt	: 5 kW
Virkningsgrad	: 80 %
Brændsel (Brug kun anbefalede brændsler) : træ Følg instrukserne i brugermanualen. Anordningen er egnet til røggasaleledning og intervalfyring.	
	SINTEF Produktdokumentation 043-168

<b>CE</b>	
Producent RAIS A/S, Industrivej 20, 9900 Frederikshavn, Danmark 07	
EN 13240:2001+A2:2004 Anordning til træ	
EC.nr. 607	
<b>RONDO 120</b>	
Afstand til brændbart, bagvæg	: 150 mm
Afstand til brændbart, sidevæg	: 350 mm
Afstand til brændbart, drejefod : (360°)	: 1050 mm
CO emission	: 0,17 %
Røggas temperatur	: 246 °C
Nominel effekt	: 5 kW
Virkningsgrad	: 80 %
Brændsel (Brug kun anbefalede brændsler) : træ Følg instrukserne i brugermanualen. Anordningen er egnet til røggasaleledning og intervalfyring.	
	SINTEF Produktdokumentation 043-168

## Installation

It is prohibited to carry out unauthorised alterations to the stove.

There must be plenty of fresh air in the room where the stove is being installed, in order to ensure proper combustion. Note that any mechanical exhaust ventilation - e.g. an extraction hood - may reduce the air supply. Any air grates must be placed in such a manner, that the air supply is not blocked.

Building Regulations Approved document J gives specific guidance on the required permanent ventilation into the room for combustion air of solid fuel appliances.

The floor structure must be able to carry the weight of the wood burning stove, as well as the weight of a chimney, if necessary.

When you choose where to set up your RAIS wood burning stove, you should consider the heat distribution to the other rooms. This will enable you to get the best use out of your stove. The stove should be set up at a safe distance from inflammable materials. See the manufacturer's plate on the wood burning stove.

### Installation with turntable (RAIS Rondo 120)

If the stove has a turntable then please do the following:

Push / pull the pedal in 15° intervals. When the stove is in the desired position, let go of the pedal and turn the stove lightly until it slips into place.

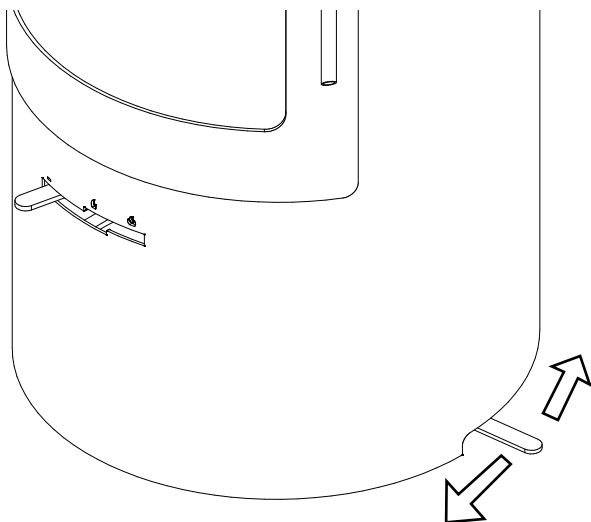

## Adjustment of chimney connection

The stove is always delivered for top connection, but can be changed to rear connection as follows:

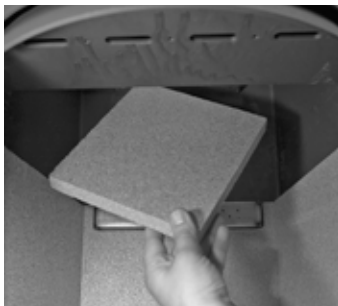

Remove baffle plate and smoke diverter (see cleaning and care).



Loosen the 3 M6 nuts with a wrench key.



Make sure that the flue diverter is fastened to the protective cover.



Lift up the reflector plate, push out the knock-out, and put the reflector plate back into place.

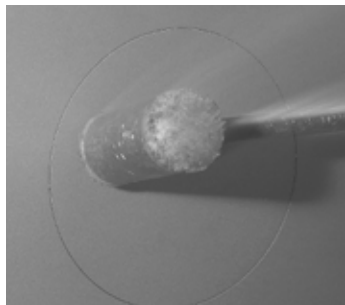

Remove the casing knock-out.



Remove protective cover and seal and place over the hole on the top - make sure that the seal is positioned properly. Tighten the assembly using the 3 M6 nuts.

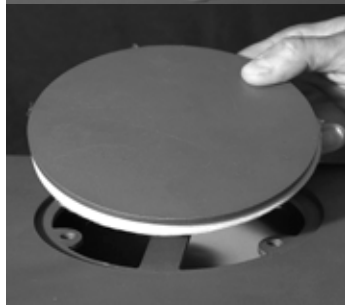

The flue outlet spigot, which you will find in a pouch in the stove, and the holder for the upper flue diverter are assembled with 3 M6x20 head cap screws and M6 nuts.

The upper flue diverter, baffle plate and top plate are assembled in reverse order.

## Installation distance in case of combustible wall

To find out whether the wall next to where the stove is going to be installed is flammable, you should contact your building contractor or the local building authorities.

The hearth should be able to accommodate the weight of the stove. The chimney must be independently supported by wall brackets or a ceiling support plate. The weight of the stove is indicated in the brochure.

The stove should always be installed on a non-combustible hearth of a size and construction that is in accordance with the provisions of the current UK Building Regulations Approved Document J.

If the stove is to be installed on a wooden floor, it must be covered with a noncombustible material at least 12mm thick, in accordance with UK Building Regulations Approved Document J, to a distance of 300 mm in front of the stove and 150 mm to each side measuring from the door of the combustion chamber.

The clearance distances to combustible material beneath, surrounding or upon the hearth and walls adjacent to the hearth should comply with the guidance on the separation of combustible material given in UK Building Regulations Approved Document J and also in these stove instructions.

Normal set-up (right-angled) secure base

	RONDO 92	RONDO 120
A.Distance to furniture	1050 mm	1050 mm
Distance to flammable materials:		
B.- in front (floor)	300 mm	300 mm
C.- to the side (floor)	150 mm	150 mm
D.- rear (wall)	150 mm	150 mm
E.- to the side of the wall	350 mm	350 mm

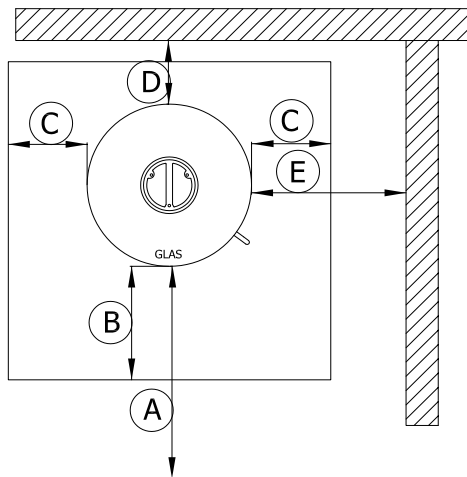

Corner set-up 45°

	RONDO 92	RONDO 120
A.Distance to furniture	1050 mm	1050 mm
Distance to flammable materials:		
B.- in front (floor)	300 mm	300 mm
C.- to the side (floor)	150 mm	150 mm
D.- rear (wall)	150 mm	150 mm
E.- to the side of the wall	350 mm	350 mm

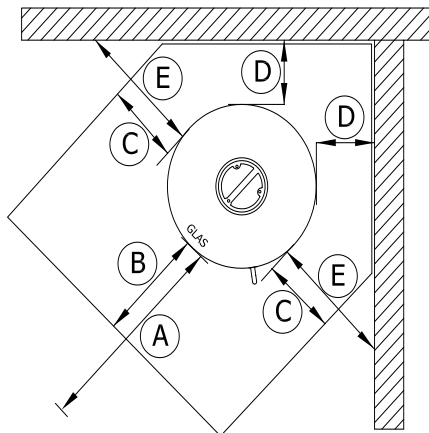

360° swivel base - normally placed as a room divider

RONDO 120

- A. Distance to furniture 1050 mm
- Distance to flammable materials:
- B. - in front (floor) 300 mm
- Distance to firewall 800 mm

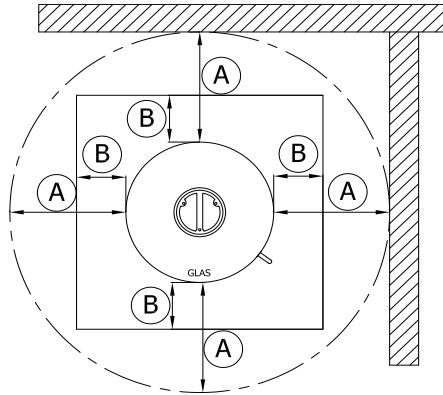

### Installation distance in case of non-combustible wall

We recommend a minimum distance to non-combustible material of 50mm(F) for cleaning considerations.

It should always be possible to access the clean-out door.

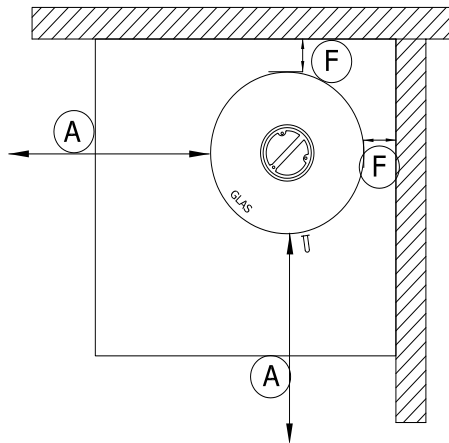

## For the Installer

Finally before firing the stove for the first time a check should be made to ensure that the assembly and stove installation has been satisfactory and that there are no leaks in any seals in the appliance and appliance connections to the chimney.

Ensure that the appliance and chimney flue are functioning correctly before finally handing over to the user. If necessary read the later parts of this manual for guidance on care required when first lighting.

Inform the user that the appliance has been commissioned and ready to use and give instruction on the safe operation of the stove.

These Instructions must be left with the user and the user should be instructed to keep them in a safe place.

## Operating instructions

Please note that HETAS Ltd Appliance Approval only covers the use of dry seasoned wood logs on this appliance. HETAS Ltd Approval does not cover the use of other fuels either alone or mixed with the wood logs, nor does it cover instructions for the use of other fuels.

### Fuel

The stove is designed and approved in accordance with EN 13240 and NS 3058 for stoking split, dried firewood. The firewood must have a water content of 15-22% and its max. length should be the length of the combustion chamber minus 50-60 mm.

Stoking with wet firewood causes both soot, environmental pollution and bad fuel economy. Freshly cut wood contains approx. 50-70% water and is thoroughly unsuitable for stoking. Count min. 1 year of storage time for newly cut wood before using. Wood with a diameter of more than 100 mm should be split. Regardless of wood size, it should always have at least one surface area free of bark.

We do not recommend stoking with painted, laminated or impregnated wood, wood with a synthetic surface, painted refuse wood, chipboard, plywood, domestic waste, paper briquettes and pit coal, as this will produce malodorous smoke, which could be poisonous.

When firing with the above-mentioned items and amounts larger than those recommended, the stove is subjected to a larger amount of heat, which results in a higher chimney temperature and lower efficiency. This can result in the stove and chimney becoming damaged and would void the warranty.

The calorific value of the firewood is closely connected to the moisture level of the firewood. Moist firewood has a low heat value. The more water the wood contains, the more energy it takes for this water to vaporize, resulting in this energy being lost.

### ONLY USE RECOMMENDED FUELS

The following table shows the calorific value of different types of wood, which have been stored for 2 years, and which have a residual moisture of 15-17%.

Wood	Kg dry wood pr. m <sup>3</sup>	compared to beech/oak
Hornbeam	640	110%
Beech and oak	580	100%
Ash	570	98%
Maple	540	93%
Birch	510	88%
Mountain pine	480	83%
Fir	390	67%
Poplar	380	65%

1 kg of wood fields the same heat energy irrespective of wood type. 1 kg beech merely takes up less space than 1 kg of fir.

## Drying and storage

Drying wood takes time: proper air drying takes approx. 2 years.

Here are some tips:

Store the wood sawn, split and stacked in an airy, sunny place, which is protected against rain (the south side of the house is particularly suitable).

Store the firewood stacks at a hand's breadth apart, as this ensures that the air flowing through takes the moisture with it. Avoid covering the firewood stacks with plastic, as this prevents the moisture from escaping. It is a good idea to bring the firewood into the house 2-3 days before you need it.

## Regulating the combustion air

All RAIS stoves are equipped with a one-handed operating lever for regulating the damper. The stove-specific regulating mechanisms can be seen on the diagrams.

Primary air is the combustion air added to the primary combustion zone, i.e. the bed of glowing embers. This air, which is cold, is only used in the lighting stage.

Secondary air is the air which is added in the gas combustion zone, i.e. air which contributes to the combustion of the pyrolysis gases (preheated air, which is used for the cleaner glass system and combustion). This air is sucked through the damper under the combustion chamber and is pre-heated through the side channels and then emitted as hot scavenging air onto the glass. The hot air rinses the glass and keeps it soot-free.

The tertiary channel, which can be seen at the top of the combustion chamber towards the back, serves to combust the final gas residues.

By setting the interval between position 1 and 2, the energy content in the firewood is used optimally, as there is oxygen for combustion and for the burning of the pyrolysis gases. When the flames are a clear yellow the damper has been set correctly. Finding the correct position comes with time after you have used for stove for a while.

It is not recommended that you turn it down completely. A mistake commonly made is shutting the damper too early because it feels too hot. This results in dark smoke emanating from the chimney and in the calorific value of the firewood not being used to its fullest.

## Room ventilation and stoves

There must not be an extractor fan fitted in the same room as the stove as this can cause the stove to emit smoke and fumes into the room.

The stove requires a permanent and adequate air supply in order for it to operate safely and efficiently.

In accordance with current Building Regulations the installer may have fitted a permanent air supply vent into the room in which the stove is installed to provide combustion air. This air vent should not under any circumstances be shut off or sealed.

## Using the wood burning stove

Adjustment of air damper  
The damper has 3 settings

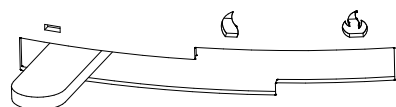

### Position 1

The air damper is closed, which means no air supply.

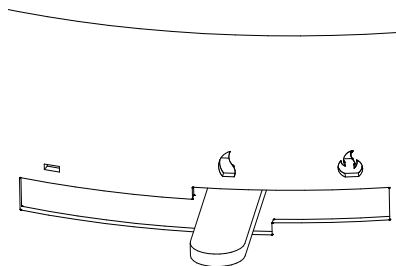

### Position 2

Push the lever to the right until it stops. This position gives full secondary air.

During normal stoking the lever is set between positions 1 and 2.

When the flames are clear and yellow, the damper is set correctly, i.e. resulting in a slow/optimal burning.

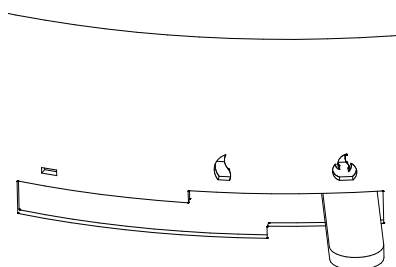

### Position 3

Lift the lever upwards and push to the right. The air damper is completely open and gives full primary and secondary air. The position is for the lighting stage and is not used under normal operation.

## Control

If the ash is white and the walls in the combustion chamber soot-free after the stove has been used, the air regulation was set correctly and the wood was sufficiently dry.

## First usage

A careful start pays off. Start with a small fire, so that the wood burning stove can get accustomed to the high temperature. This gives the best start and any damage is avoided.

Be aware that a strange but harmless odour and smoke concoction may emanate from the surface of the stove, the first time you fire up. This is because the paint and materials need to harden. The odour disappears quickly, but you should check the ventilation and draught, if possible. See also, the IMPORTANT warning notice below about persistent fumes.

During this process you must be careful not to touch the painted surfaces, and it is recommended that you regularly open and close the door to prevent the door seal from sticking.

The stove may also produce "clicking noises" during heating and cooling, caused by the large temperature differences which the material is subjected to.

Never use any type of liquid fuel for kindling or maintaining the fire. You could be at risk of explosion.

The stove gets very hot when in use always wear protective gloves when tending the stove.

If the stove has not been used for a while, follow the steps as if you were using it for the first time.

### IMPORTANT - Warning Note!

Properly installed, operated and maintained this appliance will not emit fumes into the dwelling. Occasional fumes from de-ashing and re-fuelling may occur. However, persistent fume emission is potentially dangerous and must not be tolerated. If fume emission does persist, the following immediate actions should be taken:

- (a) Open doors and windows to ventilate room.
- (b) Let the fire out or eject and safely dispose of fuel from the appliance.
- (c) Check for flue or chimney blockage, and clean if required.
- (d) Do not attempt to relight the fire until the cause of the fume emission has been identified and corrected. If necessary seek expert advice.

### IMPORTANT - Warning Note!

Do not use an aerosol spray on or near the stove when it is alight.

### IMPORTANT - Safety advice!

When using the stove in situations where children, aged and/or infirm persons are present a fireguard must be used to prevent accidental contact with the stove. The fireguard should be manufactured in accordance with BS 8423:2002 (Replaces BS 6539).

## Lighting and fuelling



To light the stove, use alcohol briquettes or similar, as well as approx. 2 kg of firewood, split into kindling sticks. Set the air damper to the fully open position.

### TIPS before firing up:

Open a door or window close to the wood burning stove.

If there is a "storm" in the stove coming from the chimney, it is advisable to place a screwed-up piece of newspaper between the upper baffle plate and the chimney, set the paper on fire, and wait until you hear a "rumbling" noise in the chimney. This means that there definitely is a draught in the chimney and you avoid smoke in the room.



Light the fire and shut the door, leaving the door ajar approx. 10-15 mm.



When the flames are clear - after approx. 5-10 min. - close the door.

Damper - see adjustment of air damper.

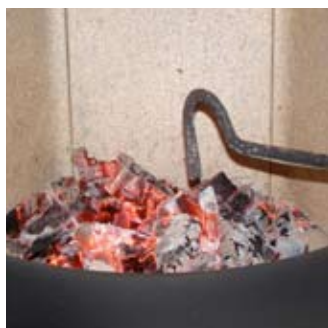

After approx. 10-20 min. - when you have a good bed of glowing embers - add 2-3 pieces of wood.

Leave the door ajar until the fire has caught on properly - close the door.

Damper - see adjustment of air damper.



After approx. 5 min. - or when the flames are clear and stable - close the damper gradually.

It is recommendable to have a layer of ash of approx. 20 mm, as it has an insulating effect.



### Note!

During operation the door should always remain shut.



## Cleaning and care

The wood burning stove and the chimney must be serviced by a chimney sweep twice a year. During cleaning and care, the stove must be cold.

If the glass is sooty:

- Moisten a piece of paper or newspaper, dip it in the ash, and rub the sooty glass with it.
- Now rub with a piece of paper and the glass will become clean.
- As an alternative you can use glass polish, which you can buy from you RAIS distributor.

Clean the exterior with a dry sponge.

## Cleaning soapstone:

Normal cleaning is done with a tightly wrung cloth. If necessary, the soapstone can be cleaned with a normal diluting agent from a paint store. If there are stains which the diluting agent cannot handle, it is possible to abrade the stone slightly.

## Cleaning the combustion chamber:

Scrape/shovel the ash out and store it in a non-flammable container until it has cooled down. You can dispose of ash with your normal household waste.

**REMEMBER!!** Never remove all the ashes from the combustion chamber - the wood will burn at its best with a layer of ashes of approx. 20 mm.

## Prolonged periods of non-use:

If the stove is to be left unused for a prolonged period of time then it should be given a thorough clean to remove ash and unburned fuel residues. To enable a good flow of air through the appliance to reduce condensation and subsequent damage, leave the air controls fully open.

Prior to a new heating season, it should be checked that the chimney and smoke gas connector are not blocked.

## Cleaning of the flue ways



Remove the baffle plate by pivoting it up at one end and tilting it slightly at an angle.

Carefully pull out the plate.



Next, remove the flue diverter by lifting it up and pulling it forward.

Carefully lift out the flue diverter.

Remove dust and dirt and assemble in reverse order.

## Interruption of operation

### Smoke spillage around door:

Could be due to too low draught in the chimney <12Pa

- Check whether the flue or chimney is blocked
- check whether the extraction hood is switched on; if it is, switch it off and open a window/door in the proximity of the stove for a short while.

### Soot on glass:

Could be because the firewood is too wet.

- make sure that the stove is heated properly when firing up, prior to closing the door

Could be because the damper regulation is too low.

A stove burning too strong could be caused by:

- leak around the door seal
- chimney draught too large >22 Pa, draught control regulator should be installed.

A stove burning too weakly could be caused by:

- too little firewood
- too little air supply for room ventilation
- unclean smoke channels
- leaky chimney
- leakage between chimney and flue

If your stove continues to malfunction, we recommend that you contact your RAIS distributor or chimney sweep.

**IMPORTANT!!** To ensure safe burning there must be clear yellow flames or clear embers at all times. The firewood should not be smoldering. Therefore you should never completely cut off the air supply.

## **WARNING!!**

In case of chimney fire:

- shut off all air supply on the wood burning stove
- contact the fire department
- never attempt to put out fire with water!
- afterwards, you should ask your chimney sweeper to check the stove and chimney

## Accessories and spare parts

If spare parts other than those recommended by RAIS are used, the warranty is voided.

All replaceable parts can be bought as spare parts from your RAIS distributor. See the following spare parts diagrams for the individual products.

## Spare parts diagram - RAIS Rondo 92

Pos	Number	Item no. / description
1	1	505700170 Soapstone top plate without hole
2	1	505700270 Soapstone top plate with hole
3	1	505060190 Top plate without hole
4	1	505060290 Top plate with hole
5	1	505061180 Stainless steel top plate without hole
6	1	505061280 Stainless steel top plate with hole
7	1	5061090 / 95 Door
8	1	5052207 Upper baffle plate
9	-	505222001 Firebrick set
10	1	607010490 / 95 Ash plate
11	-	5055500 Seal set

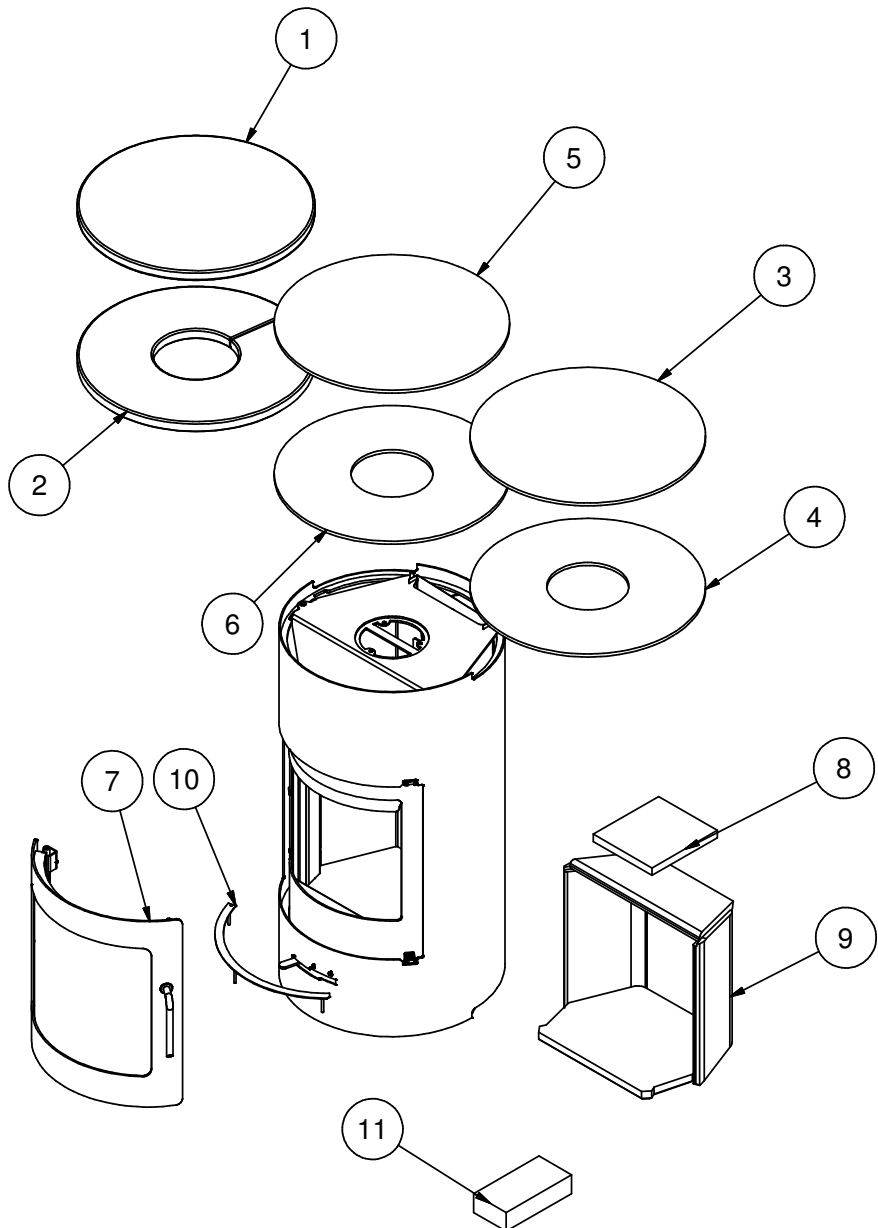

## Spare parts diagram - RAIS Rondo 120

Pos	Number	Item no. / description
1	1	505700170 Soapstone top plate without hole
2	1	505700270 Soapstone top plate with hole
3	1	505060190 Top plate without hole
4	1	505060290 Top plate with hole
5	1	505061180 Stainless steel top plate without hole
6	1	505061280 Stainless steel top plate with hole
7	1	8142390 Ball coupling
8	1	5051090 / 95 Door
9	1	6071590 Turn table
10	1	6071790 Air-box
11	1	5052207 Upper baffle plate
12	1	505222001 Firebrick set
13	-	5055500 Seal set
14	1	607010490 / 95 Ash plate

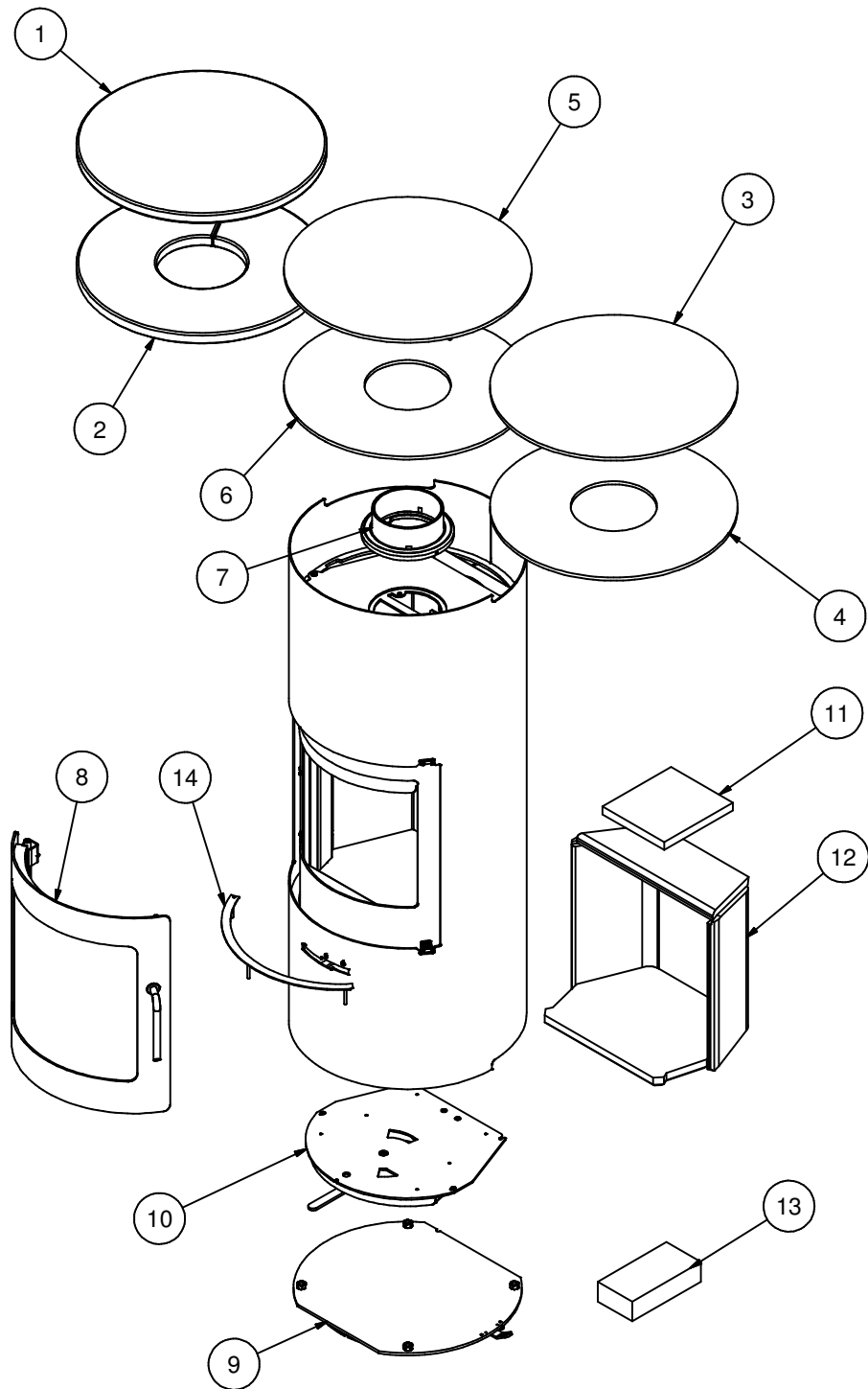

RAIS A/S  
Industrivej 20  
DK-9900 Frederikshavn  
[www.rais.dk](http://www.rais.dk)